

CFP ~~2/4/8~~ ZONE
ECONOMY
FIRE ALARM
CONTROL PANEL

**user manual
& log book**

approved document no. DFU7001009 rev 1



CONTENTS

Safety	3
Important information regarding the safe use of this fire alarm panel	
Fire Alarm Systems - An Overview	3
How fire alarm systems operate and a general overview of their key features	
User Responsibilities	4
General guidelines on what the user is expected to do	
Panel Layout / Accessing the Controls	5
A summary of the controls and indicators available on this fire alarm panel, including:-	
Control level definition	
How to access the panel's secure user functions	
What the indicators mean	
Fire Conditions	7
How an alarm is indicated, and how to deal with it	
How to silence the alarm sounders	
How to manually activate the alarm sounders (i.e. to evacuate the building)	
How to reset a fire alarm condition	
Fault Conditions	8
The different types of fault that may occur, what they mean and how to deal with them	
Disablements	9
How to inhibit the functionality of certain parts of the fire alarm system	
System Set-Up Data Chart	10
Details of how the system has been set-up	
Log Book	11
A place for you to record details of events such as fires, false alarms, call outs, etc.	
Installation Certificate	15
Commissioning Certificate	16



This product has been manufactured in conformance with the requirements of all applicable EU Council Directives.

© 2001-2003. Errors & Omissions Excepted. The Manufacturer of this product operates a policy of continuous improvement and reserves the right to alter product specifications at its discretion and without prior notice. All of the instructions covered in this manual have been carefully checked prior to publication. However, no responsibility can be accepted by the Manufacturer for any inaccuracies or for any misinterpretation of an instruction or guidance note by the User.

SAFETY

The fire alarm panel is safe to operate provided it has been installed in compliance with the manufacturer's instructions and used in accordance with this manual.



Do not operate the fire alarm panel with its enclosure open. There is no need to open the enclosure except to carry out commissioning, maintenance and remedial work. This work must only be carried out by competent service personnel who are fully conversant with the contents of the separate engineering manual for this product and have the necessary skills for maintaining this equipment.

If the enclosure is damaged in any way, expert advice should be sought regarding its repair.

Regular servicing of the fire alarm system is highly recommended, preferably on a continuous maintenance contract and by a competent organisation. A full-itemised report of the installation should be obtained at least annually.

FIRE ALARM SYSTEMS - AN OVERVIEW

The primary purpose of a fire alarm system is to provide an early warning of a fire so that people and animals can be evacuated and action taken to stop the fire as soon as possible - all according to a predetermined plan.

Alarms may be raised automatically, by smoke or heat detectors, or manually by a person operating a manual call point.

To ensure an alarm is dealt with in an orderly manner, it is important to know where the alarm is coming from. To aid this function, fire alarm systems are usually split into zones, each covering a different area of a building.

When an alarm has been raised, the fire alarm panel responds by indicating the zone in which the alarm has occurred and activating all relevant sounders, bells and other alarm outputs to provide a warning of the fire. Additional alarm outputs available on this fire alarm panel (which may or may not be used depending on the requirements of the site) are:-

- **A Remote Output:** this output is activated when the panel is in alarm and is returned to normal when the alarm sounders are silenced. It may be used to signal an alarm condition to other parts of the fire alarm system. If used, its function will be declared on the System Set-up Data Chart on page 10 of this user manual. This output may be disabled if required.
- **An Auxiliary Output:** this output is activated when the panel is in alarm and is returned to normal when the panel is reset. It may be used to signal an alarm condition to other parts of the fire alarm system. If used, its function will be declared on the System Set-up Data Chart on page 10 of this user manual. This output may be disabled if required.

The building's fire management plan should always be executed when the fire alarm panel goes into alarm.

Fault monitoring

For obvious reasons, the reliability of the fire alarm system is paramount. To this end, the fire alarm panel continuously monitors all connections between detectors, manual call points and sounders and also checks its own power supply and back-up batteries for faults.

If a fault is detected anywhere on the system, the panel responds by illuminating one or more of the fault light(s) located on the front of its enclosure and sounding its internal fault buzzer. The panel's fault output is also activated, sending notification of the fault (if connected) to a remote manned monitoring centre or other electronic equipment, as required.

Disabling

In abnormal conditions, certain parts of the fire alarm system can be temporarily turned off (disabled) to suit prevailing conditions. For example, if there is a risk of a false alarm occurring in a zone, say from vehicle exhaust smoke in a loading bay, it is possible to disable that zone during the risk period, then enable it again afterwards. Another example is the disabling of outputs during a routine test or temporary fault.

USER RESPONSIBILITIES

BS5839-1: 2002 is the British Standard code of practice for the design, installation, commissioning and maintenance of fire detection and fire alarm systems for buildings. Section 7 of the standard (User Responsibilities) states that a named responsible person should be appointed to supervise all matters pertaining to the fire alarm system {clause 47.2a}.

Highlighted below is a *summary* of the main functions the responsible person is expected to carry out with regard to BS5839-1: 2002 only. It does not highlight any other responsibilities that may be required of the user or responsible person that is listed in documentation such as the Employers Guide to Fire Safety, the Fire Precautions (Workplace) regulations and/or any other legislation relevant to the premises. If in doubt, the fire authority can advise on the fire legislation that applies to any given building.

BS5839-1: 2002 states the responsible person should:

(The bracketed numbers {xx} identify the BS5839-1: 2002 clauses to which the summary refers).

- 1** Ensure the fire alarm panel is checked daily to confirm there are no faults on the system {47.2b}
- 2** Ensure arrangements are in place for the test, maintenance and regular servicing of the system with regard to Section 6 of the standard {47.2c}.
Important: Clause 44 of BS5839-1: 2002 recommends weekly and monthly tests that should be carried out by the user/responsible person - please refer to the bottom of this page for further details.
- 3** Ensure the system log book is kept up to date by recording fire signals, fault signals, work on the system, etc, and make sure it is available for inspection at all times {47.2d / 48}
- 4** Ensure that all relevant occupants of the protected premises are instructed in the proper use of the system {47.2e}
- 5** Take steps to limit the number of false alarms on the system {47f}
- 6** Ensure the effectiveness of the system is not impaired by ensuring there is a space of at least 500mm in all directions around and below every fire detector and that all manual call points are unobstructed and easy to see {47g}
- 7** Liaise with all relevant building engineers, decorators, etc., to ensure any changes to (or maintenance of), the building's fabric does not compromise the protection given by the fire alarm system, create faults or false alarms {47h}
- 8** Ensure that any structural or occupancy changes planned for the building are done so with due and early consideration given to any changes that may be required to the fire system {47h}
- 9** Ensure that a selection of spare parts are held as appropriate within the premises {47j}

Routine weekly and monthly testing to be undertaken by the user/responsible person

To meet the requirements of Clause 44 of BS5839-1:2002 we recommend the following tests are carried out at approximately the same time each week, during normal working hours:-

Note: It is essential any alarm receiving centre is contacted before and after these tests to avoid unwanted alarms and to confirm the fire signal is correctly received.

- Carry out an Indicator lamp test to check all zone lights show and the beeper sounds.
- Operate a manual call point or smoke/heat detector to test the fire alarm.
- Check that the alarm sounders operate.
- Reset the system by pressing the Silence/Activate Sounders button and Control Panel Reset button.
- Verify that no manual call points or smoke/heat detectors are obstructed in any way.
- Test a different zone each week using a different call point or detector so all are tested in rotation.

Monthly attention: Ensure authorized service personnel verify the system's standby power supply (or supplies) are in good working order.

Quarterly and periodic inspection, testing, servicing and maintenance

It is the user's responsibility to ensure that an ongoing periodic plan is in place that meets Clause 45 (Inspection and Maintenance) of BS5839-1:2002. The work required to meet this Clause must be carried out by a competent person with specialist knowledge of fire detection and alarm systems. The standard recognises this will normally be an outside specialist fire alarm servicing organization.

Please note: the above summaries do not replace Sections 6 and 7 of BS5839-1: 2002 but are intended to help the user gain a greater understanding of his or her responsibilities. We strongly recommend the named responsible person familiarizes themselves with the full standard, copies of which are available from your local reference library or can be purchased from the British Standards Institute, Customer Services Dept., 389 Chiswick High Road, London, W4 4AL. Tel: +44 (0)20 8996 9001. Web: www.bsi-global.com

PANEL LAYOUT / ACCESSING THE CONTROLS

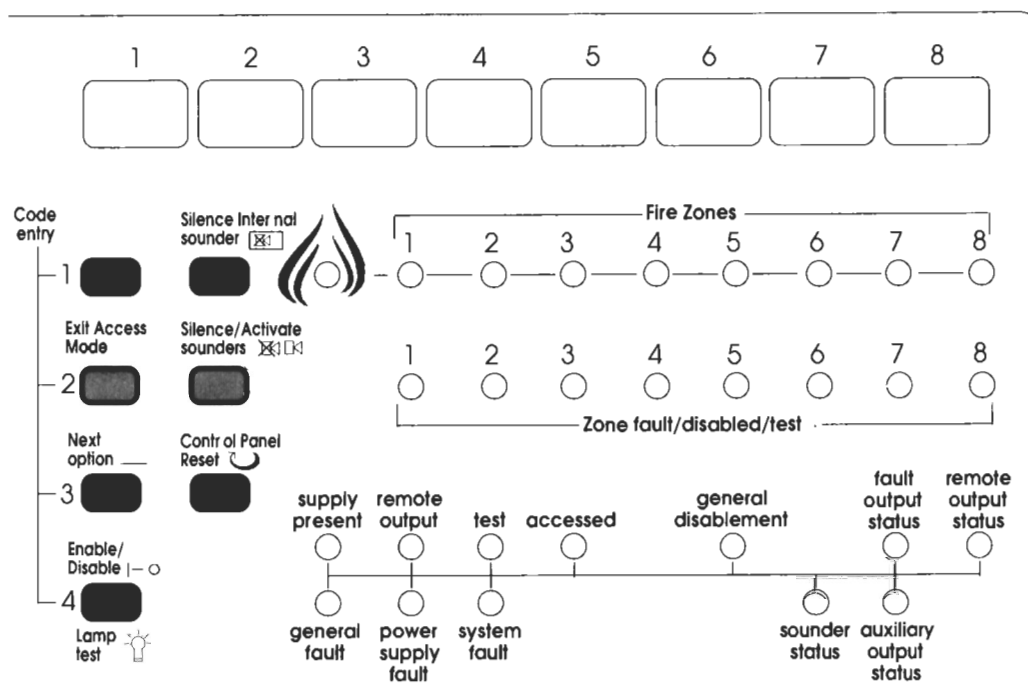

Two levels of control are available to the User(s) of this fire alarm panel - General User and Authorised User.

1. General User Controls (access level one)

When the panel is in access level one, the indicator lights on the front of the enclosure give a comprehensive overview of the system's current status. Any fire and fault conditions are clearly displayed, disablements highlighted and the status of all outputs reported. For detailed descriptions of what each indicator means, please refer to the table on the next page.

The only functions that can be performed by the user when the panel is in access level one are:-

- Muting the panel's internal sounder by pressing the Silence Internal Sounder button;
- Putting the panel into access level two (the Authorised User state) - see below.

2. Authorised User Controls (access level two)

To avoid unauthorised changes to critical parts of the fire alarm system, controls such as silencing the sounders, resetting an alarm condition and implementing disablements are only accessible via a secure method of entry which puts the panel into access level two.

To put the panel into access level two on the code entry version of the fire alarm panel:-

Enter the code **2 1 4 3** using the code entry buttons on the panel front. During the code entry sequence, the panel's Accessed light will pulse. If an incorrect sequence of numbers is entered, after four button presses the Accessed light will cease to pulse and you must enter the code again. When the correct code is entered, the Accessed light will be lit steady to show the user that the controls are operative. To leave access level two at any time, press the Exit Access Mode button.

To put the panel into access level two on the keyswitch version of the fire alarm panel:-

Turn the key to the **I** position (please note the key cannot be removed when in this position). When the key is in the **I** position, the Accessed light will be lit steady to show the user that the controls are operative. To leave the access level two, turn the key back to the **O** position.

Details of how to use the Authorised User controls can be found on pages 7, 8 & 9 of this User Manual.

What the Indicators mean

The table below summarises the various indicators available on the Fire Alarm Panel and what they mean in their various States. The final column highlights the page(s) you should turn to for further information.

INDICATOR	STATUS OF LIGHT	WHAT THIS MEANS	FURTHER READING
 (General Fire)	Flashing Red	The Panel has detected a fire alarm condition or the Activate Sounders button has been pressed to evacuate the building	Page 7 (Fire Conditions)
	Steady Red	There is a silenced fire alarm condition on the system.	Page 7 (Fire Conditions)
Fire Zones 1 to 8 ○—○	Flashing Red	A fire alarm condition has been detected on the zones which are flashing	Page 7 (Fire Conditions)
	Steady Red	There is a silenced fire alarm condition on the zones which are lit steady	Page 7 (Fire Conditions)
Zone fault/disabled/test 1 to 8 ○—○	Flashing Yellow (in sync. with the gen. fault indicator)	Faulty wiring has been detected on the zones which are flashing	Page 8 (Fault Conditions)
	Flashing Yellow (in sync. with the Test indicator)	The zones which are flashing are in test mode	
	Steady Yellow	The zones which are lit steady have been disabled	Page 9 (Disablesments)
supply present	Steady Green	The panel is supplied with power	Page 3 (Overview)
remote output	Steady Red	The remote output has been activated	Page 3 (Overview)
test	Flashing Yellow	The panel is in test mode	
accessed	Flashing Yellow	The access code is in the process of being entered	Page 5 (Accessing the Controls)
	Steady Yellow	The panel is in access level two	Page 5 (Accessing the Controls)
general disablement	Flashing Yellow	The panel is in the disablement selection state	Page 9 (Disablesments)
	Steady Yellow	Part of the system has been manually disabled	Page 9 (Disablesments)
fault output status	Flashing Yellow	Faulty wiring has been detected on the fault output's transmission path	Page 8 (Fault Conditions)
	Steady Yellow	The fault output has been disabled	Page 9 (Disablesments)
remote output status	Flashing Yellow	Faulty wiring has been detected on the remote output's transmission path	Page 8 (Fault Conditions)
	Steady Yellow	The remote output has been disabled	Page 9 (Disablesments)
general fault	Flashing Yellow	A fault has been detected on the system	Page 8 (Fault Conditions)
power supply fault	Flashing Yellow	The panel has detected a fault with its power supply, battery charger or back-up batteries	Page 8 (Fault Conditions)
system fault	Flashing Yellow	The panel has detected a microprocessor fault	Page 8 (Fault Conditions)
sounder status	Flashing Yellow	Faulty wiring has been detected on the panel's sounder circuits	Page 8 (Fault Conditions)
	Steady Yellow	The alarm sounders have been disabled	Page 9 (Disablesments)
auxiliary output status	Steady Yellow	The panel's auxiliary output has been disabled	Page 9 (Disablesments)
	Flashing Yellow	Faulty wiring has been detected on the auxiliary output's transmission path	Page 8 (Fault Conditions)

Testing the Indicator Lights

To test the panel's indicator lights are working correctly, press the Lamp Test button  when the panel is in the Accessed state.

The panel's internal beeper will also sound when pressing the button to show it is working correctly.

FIRE CONDITIONS

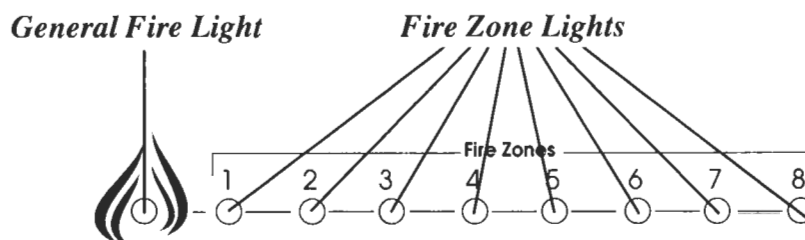

When the fire alarm panel receives an alarm trigger from a detector or manual call point located in a zone that is not already in a fire state, it will:-

- Flash the general fire and appropriate fire zone light(s) on the front of its enclosure
- Sound its internal sounder
- Start the alarm sounders and outputs including, if enabled, the remote output

At this point the building's fire management plan should be executed.



Important Note: Zones which have been disabled cannot be triggered into an alarm condition (see page 9 for further information on disablements).

Silencing the alarm sounders

- The alarm sounders may be silenced by putting the panel into access level two and momentarily pressing the Silence / Activate Sounders button .

The alarm sounders and the panel's internal sounder will cease to sound and the light(s) for the zone(s) in alarm and the red general fire light will be lit steady. All other alarm outputs (i.e. the remote and auxiliary fire outputs) will remain asserted.

New zone In alarm

Should a new zone be triggered into alarm whilst the alarm sounders are silenced, the panel will:-

- Automatically reactivate the alarm sounders
- Flash the general fire and appropriate fire zone light(s) for any new zone(s) in alarm
- Keep the light(s) for the previous zone(s) in fire lit steady

Manually activating the alarm sounders (i.e. to evacuate the building)

- Momentarily pressing the Silence / Activate Sounders button when the panel is in access level two (see page 5) will cause the alarm sounders to sound. Note: The panel's remote and auxiliary fire outputs will not be triggered when the building is manually evacuated in this way.

Pressing the Silence / Activate Sounders button again will silence the alarm sounders.

NB: If the sounders have been disabled, pressing the Silence/Activate Sounders button will have no effect.

Resetting the panel

- After the cause of the alarm has been investigated and cleared and the alarm sounders have been silenced, the panel can be reset by pressing the Control Panel Reset button .

The Panel will give a double beep to indicate the reset process has started and, after a few seconds, the zone fire and general fire lights will go out to indicate the process is complete. If there are still alarm triggers on any zone the panel will go back into alarm as before.

Exiting access level two

To exit access level two at any time, press the Exit Access Mode button (or, on the keyswitch version of the panel, turn the key back to the **O** position).

FAULT CONDITIONS

When a fault occurs on a critical part of the fire alarm system, the panel responds by activating its internal sounder and illuminating the general fault light and any other fault light(s) relating to the fault. The panel's fault output will also activate (provided it hasn't been disabled). The type of faults typically indicated at the fire alarm panel are described below:-

General Fault

The general fault light flashes when there is a fault on any part of the fire alarm system. It is always lit in tandem with at least one other fault light which conveys more precise information on the type of fault detected.

Zone Fault

The relevant zone fault light flashes when there is a wiring problem on a zone or a detector has been removed from its base. It should be noted that any alarms raised on the faulty zone(s) may not be recognised by the fire alarm panel until the fault condition has been cleared.

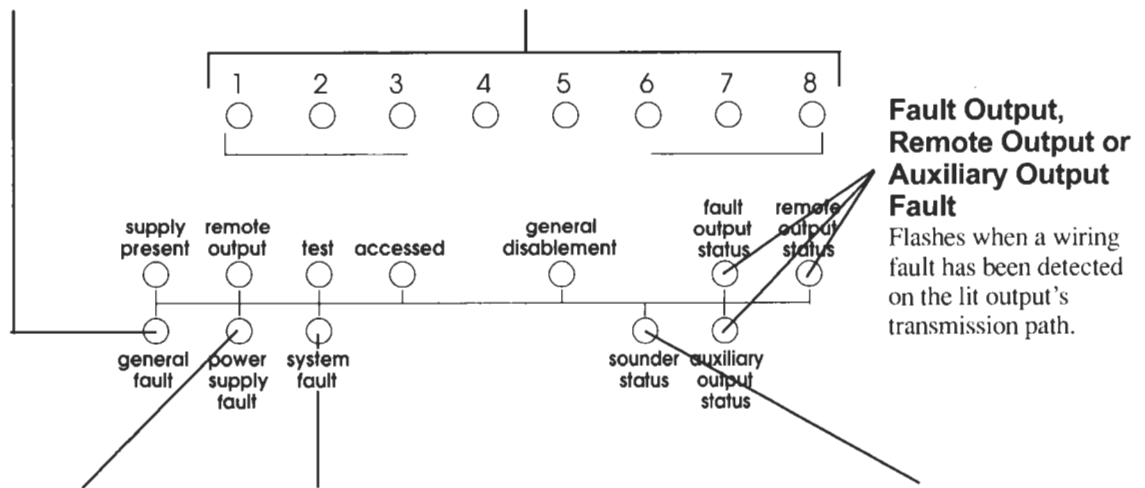

Fault Output, Remote Output or Auxiliary Output Fault

Flashes when a wiring fault has been detected on the lit output's transmission path.

Power Supply Fault

The power supply fault light flashes when the mains supply has failed, or the standby batteries or its charger are faulty. If the mains supply fails, the panel will only operate for the standby period dictated by the size of the batteries fitted. If the batteries or charger fail at the same time as the Mains, the Panel will be inoperative.

System Fault

The system fault light flashes when the panel's microprocessor has reset, typically after excessive electrical interference, or if the contents of its memory have been corrupted. This fault can only be cleared by pressing the Control Panel Reset button . If the fault re-occurs within two minutes, this is indicative of a corrupt memory and expert advice should be sought.

Sounder Fault

The Sounder Status light flashes when there is a wiring fault on the sounder circuits. Depending on where the fault has occurred, one or all of the alarm sounders may no longer be operative.

In the event of a fault condition

- Mute the panel's internal sounder by pressing the Silence Internal Sounder button  (The panel does not have to be in access level two to do this).
- Note the fault(s) down in the Log Book at the back of this manual and take appropriate action to correct it / them. See the User Responsibilities section on page 4.

When a fault has been rectified the indicator light for that fault is automatically turned off. If all faults are cleared, the general fault light will go out, and the panel's internal sounder will be silent (if not already muted). If the fire alarm panel is reset any existing fault(s) will reappear as before and the silencing process will have to be repeated.

DISABLEMENTS

Certain fire alarm panel functions can be temporarily disabled (i.e. switched off) to suit prevailing conditions. For example, if there is a risk of a false alarm in a zone, say from vehicle exhaust smoke in a loading bay, it is possible for the user to disable that zone during the risk period and enable it again afterwards. Another example is the disablement of outputs during a routine test or temporary fault. Following is a list of options that may be disabled by the user at the fire alarm panel and the effect their disablement will have on how the system works:-

OPTION	EFFECT ON SYSTEM WHEN DISABLED
Zone 1	Alarms and faults on zone 1 will not be processed
Zone 2	Alarms and faults on zone 2 will not be processed
Zone 3 (only available if fitted)	Alarms and faults on zone 3 will not be processed
Zone 4 (only available if fitted)	Alarms and faults on zone 4 will not be processed
Zone 5 (only available if fitted)	Alarms and faults on zone 5 will not be processed
Zone 6 (only available if fitted)	Alarms and faults on zone 6 will not be processed
Zone 7 (only available if fitted)	Alarms and faults on zone 7 will not be processed
Zone 8 (only available if fitted)	Alarms and faults on zone 8 will not be processed
Fault output	Faults will not be transmitted to any other equipment (if fitted)
Remote output	Alarms will not be transmitted to remote equipment (if fitted)
Sounders	The alarm sounders will not operate in a fire condition
Auxiliary output	Alarms will not be transmitted to local fire fighting equipment (if fitted)

To disable or enable any of the above options

Put the fire alarm panel into access level two (see page 5).

1 Start the selection process by pressing the Next Option button .

The general disablement light will flash and the fault light relating to the first option in the above table will flash to show it is selected.

If the light flashes at a slower rate than the general disablement light, the option is enabled
If the light flashes at the same rate as the general disablement light, the option is disabled

2 If necessary, press the Enable/Disable button to toggle the selected option between disabled and enabled.

3 To confirm your choice, press the Next Option button .

This will move the selection process on to the next available option in the above table and the fault light relating to this new option will flash to show it is selected.

The previous option's fault light will now be lit steady to confirm it is disabled or switched off to confirm it is enabled.

4 Repeat steps 2 & 3 for every available option until the selection process is complete.

The disablement/enabling process is complete when all available options have been selected in turn and the Next Option button is pressed for the last time. At this point all disabled options will be lit steady and all enabled options will have their lights switched off.

To save time, the selection process can be exited at any time by pressing the Exit Access Mode button (the only changes that will be saved will be those made prior to the last press of the Next Option button)

To avoid confusion, during the selection process any light which was showing a Fault Condition will have its fault indication turned off. After the selection process is complete, fault indication will be restored unless that option was disabled during the selection process.

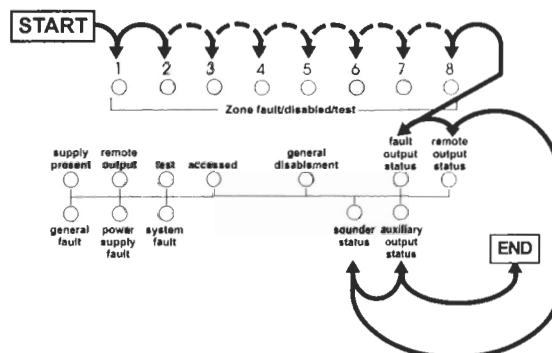

SYSTEM SET-UP DATA CHART

Important: This page should be carefully completed by an authorised engineer prior to system hand-over.

FIRE ZONE INFORMATION	
ZONE NUMBER	ZONE DESCRIPTION A concise explanation of the rooms and areas contained in each Zone
1	Hall callpoint - Smoke Hall Smoke upper Stairs
2	Library Smoke - Lounge Heat Call point Back Door + Kitchen Heat
3	Gas Room Heat - Tac Room Smoke Side Door Call point + Shower Room Smoke
4	Bunk room 23.30 smoke - Bunk Room 17.22 Large loft heat - Landing Smoke + Small loft Heat
5	
6	
7	
8	

OUTPUT ROUTING INFORMATION		
TYPE OF OUTPUT	CONNECTED?	WHAT HAPPENS WHEN ACTIVATED?
REMOTE OUTPUT	Yes /No	
AUXILIARY OUTPUT	Yes /No	
FAULT OUTPUT	Yes No	Sounder will Activate
RESET OUTPUT	Yes No	System Reset

ADDITIONAL INFORMATION
Any additional information the user needs to know should be entered in this box, i.e. the routing of additional outputs, details of inputs utilised, etc.

THE INFORMATION ABOVE WAS COMPLETED BY (name) D. Gardner
 OF (company) D. S. Securities ON (date) 23.7.08

FIRE ALARM LOG BOOK

It is recommended that this log book be maintained by a responsible person, who should ensure that every entry is properly recorded. This is necessary to satisfy the recommendations of BS5839-1: 2002, compliance with which may be a requirement of legislation. If your premises are certificated under the Fire Precautions Act 1971, failure to keep a suitable log book may be a breach of the requirements of the certificate, which is a criminal offence. In order to satisfy the requirements of BS5839-1: 2002, the following must be recorded:-

- The name of the responsible person;
- Brief details of the maintenance arrangements;
- Dates and times of all tests, including fire drills;
- Dates and times of all fires to which the system responds;
- Dates and times of all false alarms;
- Causes, circumstances surrounding, and category of false alarms (if known);
- The identity of any manual call point or fire detector that triggers any of the above fire alarm signals (if known);
- Dates, times and type of all faults and defects.
- Dates and times of all maintenance (e.g service visit or non-routine attention).

USER:	Jeremy Gilson
SITE ADDRESS:	Nondrach Cottage Charterhouse on Mendips Stagdon BS40 7XW
RESPONSIBLE PERSON(S) ON SITE:	Jeremy Gilson or Don Vosper
THE SYSTEM WAS DESIGNED BY:	Peter Coole
THE SYSTEM WAS INSTALLED BY:	Darren Gardner + Jamie Loud
THE SYSTEM WAS COMMISSIONED BY:	Darren Gardner
THE SYSTEM WAS ACCEPTED BY:	
VERIFICATION WAS UNDERTAKEN BY:	

FOR SERVICE (DETAILS OF WHO YOU SHOULD CONTACT IF MAINTENANCE IS REQUIRED)

THE SYSTEM IS MAINTAINED UNDER CONTRACT BY:	
Company:	D.S. Securities
Address:	47 Oxford Street W-S-m BS40 7XW
Contact No:	01934 417730
Expiry Date:	
NORMAL HOURS (MON-FRI) TEL:	9am - 5pm
OUTSIDE NORMAL HOURS TEL:	Ring Normal Number and get Number off Answer Machine
MANNED CENTRE TEL:	NA
MANNED CENTRE CODE:	NA
THE NORMAL MAXIMUM ATTENDANCE TIME FOR A MAINTENANCE TECHNICIAN IS:	

EXPENDABLE COMPONENT REPLACEMENT PERIODS (LIST):-

BS5839-1:2002 recommends that certificates be issued for all aspects of the fire alarm system including design, installation, commissioning, acceptance, verification (optional) and maintenance. Therefore, before this user manual is handed over, the following installation certificate and the commissioning certificate (overleaf) should be completed as appropriate by the relevant installation/commissioning engineer(s). Please ensure that the system set-up data chart on page 10 and the relevant parts of the system Log Book on page 11 are also completed as appropriate.

Certificate of INSTALLATION

for the fire alarm system at:

Address: MCC HQ Woodack Cottage
Charterhouse on Newell, IS60 7XW

I/we being the competent person(s) responsible (as indicated by my/our signatures below) for the installation of the fire alarm system, particulars of which are set out below, CERTIFY that the said installation for which I/we have been responsible complies to the best of my/our knowledge and belief with the specification described below and with the recommendations of Section 4 of BS5839-1: 2002, except for the variations, if any, stated in this certificate.

Name (in block letters): DARREN GARDNER
Position (in block letters): ENGINEER
Signature: [Signature]
Date: 23.7.08,
For and on behalf of: D.S. Securities
Address & postcode: 47 Oxford Street
W-5-M BS23 1TW

The extent of the liability of the signatory is limited to the system described below.

Extent of installation work covered by this certificate:

Specification against which the system was installed:

Variations from the specification and/or Section 4 of BS5839-1:2002 (see BS5839-1:2002, Clause 7):

Wiring has been tested in accordance with the recommendations of Clause 38 of BS5839-1: 2002.
Test results have been recorded and provided to: _____

Unless supplied by others, the "as fitted" drawings have been supplied to the person responsible for commissioning the system (see 36.2m) of BS5839-1: 2002: _____

BS5839-1:2002 recommends that certificates be issued for all aspects of the fire alarm system including design, installation, commissioning, acceptance, verification (optional) and maintenance. Therefore, before this user manual is handed over, the following commissioning certificate and the installation certificate (overleaf) should be completed as appropriate by the relevant installation/commissioning engineer(s). Please ensure that the system set-up data chart on page 10 and the relevant parts of the Log Book on page 11 are also completed as appropriate.

Certificate of COMMISSIONING

for the fire alarm system at:

Address: MCG Headquarters, Northwick Cottage
Charterhouse on Mendip BS40 7XW

I/we being the competent person(s) responsible (as indicated by my/our signatures below) for the commissioning of the fire alarm system, particulars of which are set out below, CERTIFY that the said work for which I/we have been responsible complies to the best of my/our knowledge and belief with the specification described below and with the recommendations of Clause 39 of BS5839-1: 2002, except for the variations, if any, stated in this certificate.

Name (in block letters): DARREN GARDENER
 Position (in block letters): ENGINEER
 Signature: [Signature]
 Date: 23rd July 2008
 For and on behalf of: D.S. Securities
 Address & postcode: 47 Oxford Street
W-5-m BS23 1TN

The extent of the liability of the signatory is limited to the system described below.

Extent of system covered by this certificate:

Variations from the recommendations of Clause 39 of BS5839-1:2002 (see BS5839-1:2002, Clause 7):

- All equipment operates correctly
- Installation work is, as far as can reasonably be ascertained, of an acceptable standard
- The entire system has been inspected and tested in accordance with the recommendations of 39.2c of BS5839-1:2002.
- The system performs as required by the specification prepared by: Peter Coble
a copy of which I/we have been given.
- Taking into account the guidance contained in Section 3 of BS 5839-1:2002, I/we have not identified any obvious potential for an unacceptable rate of false alarms.
- The documentation described in Clause 40 of BS5839-1:2002 has been provided to the user.

The following work should be completed before/after (delete as applicable) the system becomes operational:

NA

The following potential cause(s) of false alarms should be considered at the time of the next service visit:

Before the system becomes operational, it should be soak tested in accordance with the recommendations of 35.2.6 of BS5839-1:2002 for a period of: _____ (enter a period of either one week, such period as required by the specification, or such period as recommended by the signatory of this certificate, whichever is the greatest, or delete if not applicable).



Securities

Specialists in
Intruder Alarms, Fire Alarms and Closed Circuit T.V. Systems
for Domestic, Commercial & Industrial Premises

White - Customer
Blue - Office
Yellow - Office

47 Oxford Street
Weston-super-Mare
Somerset BS23 1TN
www.ds-securities.co.uk



Telephone (01934) 417730
Fax (01934) 417740
E Mail: intruder@ds-securities.co.uk
E Mail: peter-carter@btconnect.com

CERTIFICATE NO. NAC/G/1787

CORRECTIVE MAINTENANCE REPORT

Customer <i>MCC HQ</i>	Date <i>27.7.08</i>	Serial No.
Address <i>Nordruch Cottage</i>	Location e.g. office, stores etc.	
<i>Charterhouse on Mendips</i>	Spec No.	

Reported fault	Circuit No.
Type of Signalling <input type="checkbox"/> DC <input type="checkbox"/> DL <input type="checkbox"/>	Circuit Location
Red abc/RedCARE <input type="checkbox"/> 999 <input type="checkbox"/> Audible <input type="checkbox"/>	Device Type
	Device Model

Cause of Callout	Firm's own cause code may be inserted here		
1. CUSTOMER RELATED <input type="checkbox"/>	2. COMPANY RELATED <input type="checkbox"/>	3. LINE FAULT RELATED <input type="checkbox"/>	

Further detail and action taken

Fitted Fire Alarm System with

- 8 Smoke Detectors*
- 3 Heat Detectors*
- 3 Call points*

Reset Yes/No.

Method of Resetting

Charge Yes/No.

Amount £

Time Arrival Dep.

Time Taken Travel Time

Materials: Cost £

Used

The system has been left in full working order apart from the items and/or disconnections listed below:

Engineer's/Technician's initials <i>[Signature]</i>	Office Use	Time <input type="text"/>
Customer's Signature <i>[Signature]</i>	Initials	<input type="text"/>